

N1 Series Three-Wheel Dual Front-Drive Electric Counterbalanced Forklift

FE3D16-20N1

1600-2000 kg Capacity
80V Li-ion

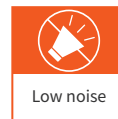
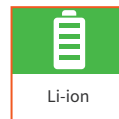

Why choose between price and quality **WHEN YOU CAN HAVE BOTH!**

HIGHLIGHTS

- ▶ Competitive cost
- ▶ Comfortable, large cabin
- ▶ High-Capacity 80V Lithium Battery
- ▶ High-Power Motor, High Efficiency
- ▶ High-strength chassis design for lithium-ion battery solution
- ▶ High-Strength, wide-view Overhead Guard
- ▶ Large-size Tilt Cylinder
- ▶ High-Load Rear Wheel



FE3D16-20N1

1600-2000 kg. Capacity

The N1 Series three-wheel dual front-drive forklift is a new series developed by Noblift, based on the C Series three-wheel compact forklift. While maintaining the family-standard design of electric forklifts, this series inherits and advances the existing design, offering even greater efficiency, flexibility, and comfort.

INNOVATIVE SOLUTIONS

New Power • Ready to Go



Dual charging port design: The vehicle charger is standard and is equipped with fast charging and slow charging ports for selection. The charging port is located at the rear, which makes it convenient to charge multiple vehicles side by side.



Excellent Ergonomic Design

- ▶ Comfortable, large cabin: The short chassis and tight turning radius provide 40% more maneuvering space than the previous model, the optimized cabin space also allow for a suspension seat.
- ▶ All-in-one overhead display instrument.
- ▶ The space above the suspended seat meets the "European Standard".
- ▶ Larger operating space, 40% more space than the old model.



Easy operations and maintenance

Better maintainability: The dual-drive motor, hydraulic motor and hydraulic oil system have large inspection space and more convenient maintenance.

Overall protection: The vehicle's protection level is **IPX4**; the motor/lithium battery is **IP65**; the electronic control is arranged inside the counterweight, which not only improves the natural heat dissipation capacity but also provides better protection.

vehicle's protection level: **IPX4**

Motor and battery protection rating: **IP65**

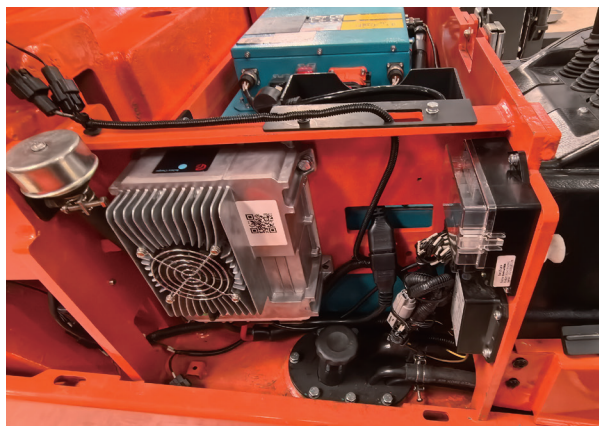
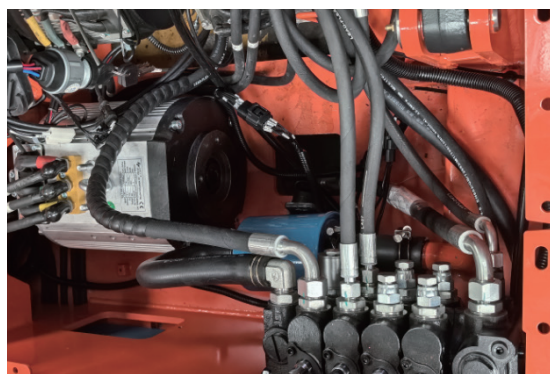

Convenient on-board charger.

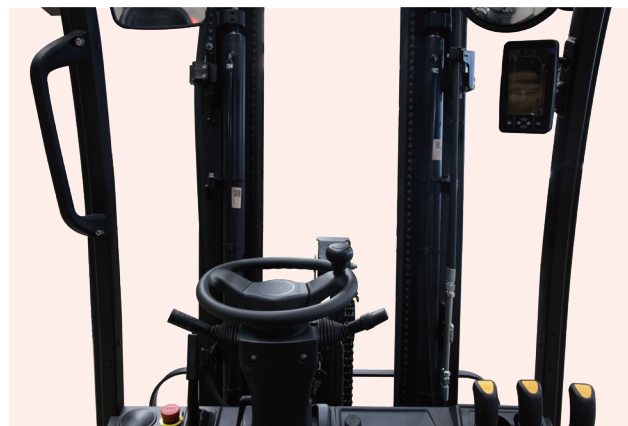

The wide-view mast makes handling cargo more convenient.

Safe and Reliable



High-strength overhead guard with wide field of view.



The rear wheels have been upgraded from the original 15X4 1/2-8 to 140/55-9 tires to increase their carrying capacity.

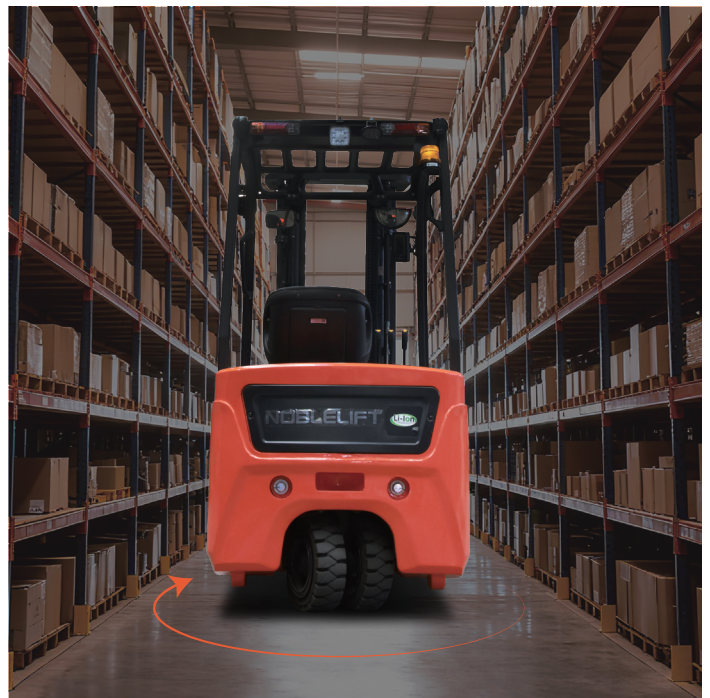

The compact design and small turning radius make it suitable for working in confined spaces.

Identification	1.1	Manufacture(abbreviation)		Noblelift	Noblelift	Noblelift
	1.2	Manufacturer's type designation		FESD1	FESD1	FESD1
	1.3	Drive		electric	electric	electric
	1.4	Type of operation		seated	seated	seated
	1.5	Load capacity/rated load	Q(kg)	1600	1800	2000
	1.6	Load centre distance	c (mm)	500	500	500
	1.8	Load distance,centre of drive axle to fork	x (mm)	372	377	377
	1.9	wheelbase	y (mm)	1360	1360	1360
	Weights	2.1	Service weight incl. battery(see line 6.5)	kg	3080	3200
2.2		Axle loading ,laden front/rear	kg	4160/520	4450/550	4790/610
2.3		Axle loading,unladen front/rear	kg	1470/1610	1530/1670	1640/1760
Wheels, Chassis	3.1	Type:solid rubber,superelastic,pneumatic,polyurethane		solid rubber	solid rubber	solid rubber
	3.2	Tyres size,front		18×7-8	18×7-8	200/50-10
	3.3	Tyres size,rear		140/55-9	140/55-9	140/55-9
	3.5	Wheels,number front/rear(×=driven wheels)		2×/2	2×/2	2×/2
	3.6	Track width,front	b10 (mm)	902	902	940
	3.7	Track width,rear	b11 (mm)	210	210	210
	Basic Dimensions	4.1	Mast/fork carriage tilt forward/backward	$\alpha/\beta(^{\circ})$	5/7	5/7
4.2		lowered mast height	h1(mm)	1995	1995	1995
4.3		Free lift	h2(mm)	120	125	125
4.4		Extended mast height	h3(mm)	3000	3000	3000
4.5		Extended mast height	h4(mm)	3955	3955	3955
4.7		Overhead load guardheight	h6(mm)	2100	2100	2100
4.8		Seat height/standing height	h7(mm)	1005	1005	1005
4.12		Coupling height	h10(mm)	520	520	520
4.19		Overall length	l1(mm)	2925	3080	3080
4.20		Length to face of forks	l2(mm)	2005	2010	2010
4.21		Overall width	b1(mm)	1084	1084	1145
4.22		Fork dimensions	s/e/l(mm)	35/100/920	40/100/1070	40/100/1070
4.24		Fork carriage width	b3 (mm)	1040	1040	1040
4.31		Ground clearance ,laden,under mast	m1(mm)	115	115	115
4.32		Ground clearance,centre of wheelbase	m2(mm)	105	105	105
4.33		Aisle width for pallets 1000×1200 crossways	Ast(mm)	3318	3323	3323
4.34	Aisle width for pallets 800×1200 lengthways	Ast(mm)	3443	3447	3447	
4.35	Turning radius	Wa(mm)	1620	1620	1620	
Performance Data	5.1	Travel speed,laden/unladen	km/h	15/15	15/15	15/15
	5.2	Lift speed,laden/unladen	m/s	0.40/0.50	0.40/0.50	0.40/0.50
	5.3	lowering speed,laden/unladen	m/s	0.50/0.50	0.50/0.50	0.50/0.50
	5.5	Max.Drawbar pull,laden/unladen	N	11500/10500	12500/11500	13500/12500
	5.7	Max.Gradient performance,laden/unladen	%	15/20	15/20	15/20
	5.10	Service brake		hydraulic	hydraulic	hydraulic
E-Motor	6.1	Drive motor rating S2 60 min	KW	5.5*2	5.5*2	5.5*2
	6.2	Lift motor rating at S3 15%	KW	12	12	12
	6.3	Battery standard		Lion	Lion	Lion
	6.4	Battery voltage,nominal capacity K5	V/Ah	76.8/150(277/412)	76.8/150(277/412)	76.8/150(277/412)
	6.5	Battery weight	kg	160/230/300	160/230/300	160/230/300
		Battery dimensions l/w/h	mm	819×400×605	819×400×605	819×400×605
Other Details	10.1	Type of drive control		AC	AC	AC
	10.2	Operating pressure for attachments	Mpa	17.5	17.5	17.5
	10.4	Oil volume for attachments	l/min	36	36	36
	10.8	Sound level at driver's ear according to EN 12 053	dB(A)	73	73	73

FE3D16-20N1 Series Mast Data Sheet

Designation	Lift height h3 (mm)	Free Lift height h2 (mm)	Closed mast height h1 (mm)	Extended mast height h4 (mm)	Tilt forward/ backward α/β (°)	Capacity table(kg) C=500mm without sideshift single solid tyres		
						FE3D16C	FE3D18C	FE3D20C
Two-stage ZT	2500	125	1745	3455	5/7	1600	1800	2000
	2700	125	1845	3655	5/7	1600	1800	2000
	3000	125	1995	3955	5/7	1600	1800	2000
	3300	125	2145	4255	5/7	1600	1800	2000
	3500	125	2245	4455	5/7	1600	1800	2000
	3700	125	2345	4655	5/7	1600	1800	2000
	4000	125	2545	4955	3/5	1500	1800	2000
	4300	125	2695	5255	3/5	1450	1700	1900
Two-stage ZZ	2500	790	1745	3455	5/7	1600	1800	2000
	2700	890	1845	3655	5/7	1600	1800	2000
	3000	1040	1995	3955	5/7	1600	1800	2000
	3300	1190	2145	4255	5/7	1600	1800	2000
	3500	1290	2245	4455	5/7	1600	1800	2000
	3700	1390	2345	4655	5/7	1600	1800	2000
	4000	1590	2545	4955	3/5	1500	1750	1900
Three-stage DZ	4000	985	1940	4955	3/5	1500	1750	1900
	4350	1110	2065	5305	3/5	1450	1700	1850
	4500	1160	2115	5455	3/5	1400	1600	1800
	4799	1200	2155	5755	3/5	1300	1500	1600
	5000	1360	2315	5955	3/5	1200	1450	1500
	5500	1510	2465	6455	3/5	1100	1200	1300
	6000	1710	2665	6955	3/5	800	900	1000
	6500	1910	2865	7455	3/5	500	650	750

Structural Diagram

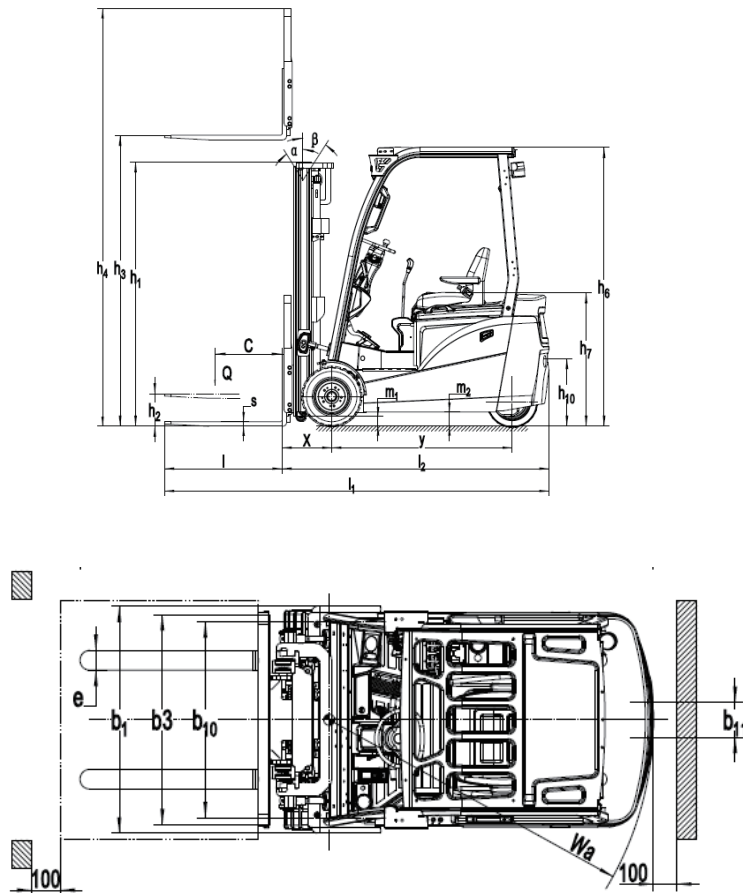

A GLOBAL LEADER

NOBLELIFT CHINA

Address: 528 Changzhou Road, Taihu
Sub-district, Changxing, Zhejiang 313100 China
Tel: 86-572-6210817 6210311
Fax: 86-572-6210777 6128612
Email: info@noblelift.com
Http: www.noblelift.com www.noblelift.cn

NOBLELIFT NORTH AMERICA

Address: 2461 S Wolf Road Des Plaines, IL 60018
Tel: 001-847-595-7100
Fax: 001-847-595-7200
Email: sales@nobleliftna.com
Http: www.nobleliftna.com

NOBLELIFT SOUTH EAST ASIA

No. 7, Jalan Astaka U8/84A, Seksyen U8, Bukit Jelutong,
40150 Shah Alam, Selangor Darul Ehsan, Malaysia.
Tel: +603 7831 8555
Email: sales@nobleliftsea.com
https: www.nobleliftsea.com

NOBLELIFT SOUTH EAST ASIA (Vietnam) CO., LTD.

Address: 3rd floor, No. 107, Street 37, Van Phuc
Residential Area, Hiep Binh Phuoc Ward, Thu
Duc City, Ho Chi Minh City, Vietnam
Tel: 84-902 598 460
E-mail: marketingvn@nobleliftsea.com
www.nobleliftsea.com.vn

NOBLELIFT RUSSIA

ООО «Ноблелифт Рус», 195067, Санкт-Петербург
пр. Маршала Блюхера, д. 78, литер Б
Тел.: +7-800-700-28-97
Email: sales@noblelift.com.ru
Http: www.noblelift.com.ru

NOBLELIFT EUROPE

Industrie park 2, 48739 Legden, Germany
Tel : +49 2566 90902-0
Email: Mail@Noblelift-Germany.com
Http: www.noblelift.com

NOBLELIFT KOREA CO., LTD.

Address: 715-9 Jubook-ri, Cheoin-gu, Yongin-si,
Kyunggi-do, Korea
Tel: 82-031 334 1828
E-mail: info@noblelift.com
www.noblelift.com

NOBLELIFT CANADA INC.

Address: 850, Ellingham Avenue, Pointe-Claire, province
of Québec, Canada, H9R 3S4
Tel: 1- 514 697 0117
E-mail: info@nobleliftca.com
www.nobleliftcanada.com

NOBLELIFT INTELLIGENT EQUIPMENT CO., LTD.



Official website



Our Wechat



LinkedIn



facebook



YouTube

